

TOP VIEW

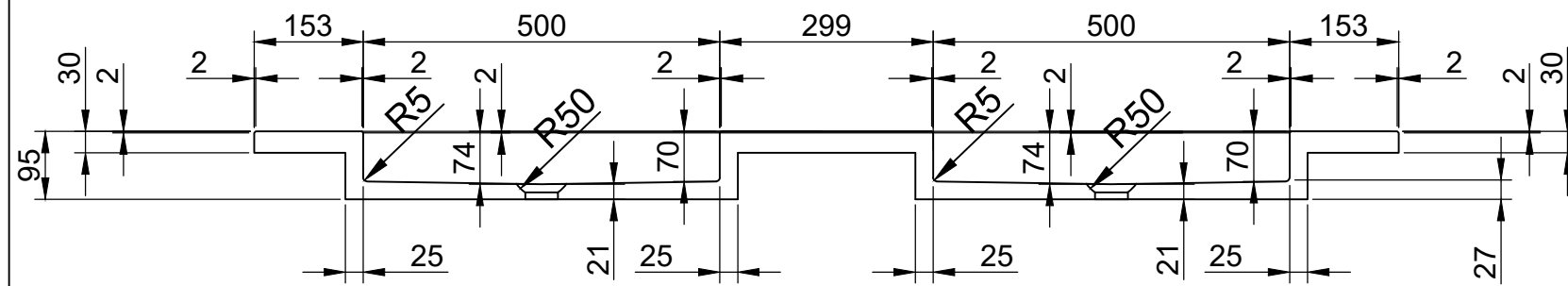

SECTION A-A

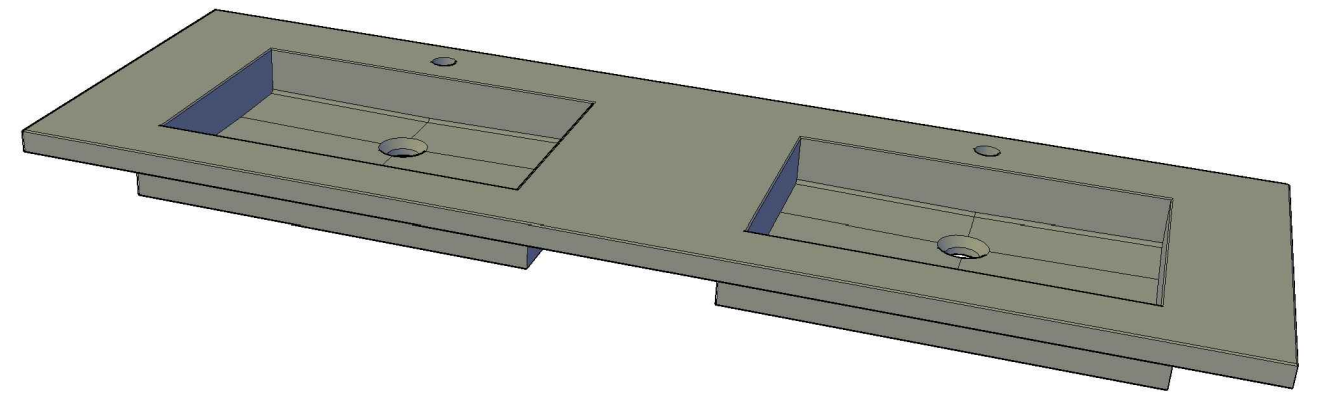
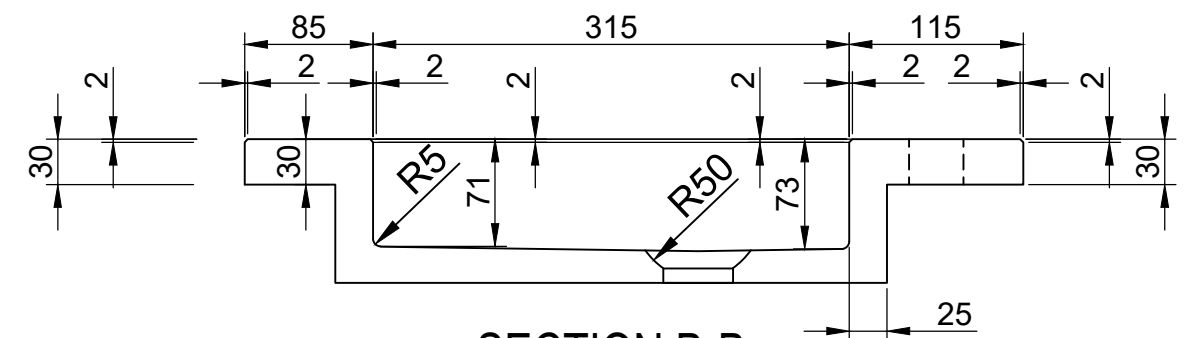

SECTION B-B  
SCALE 1:5

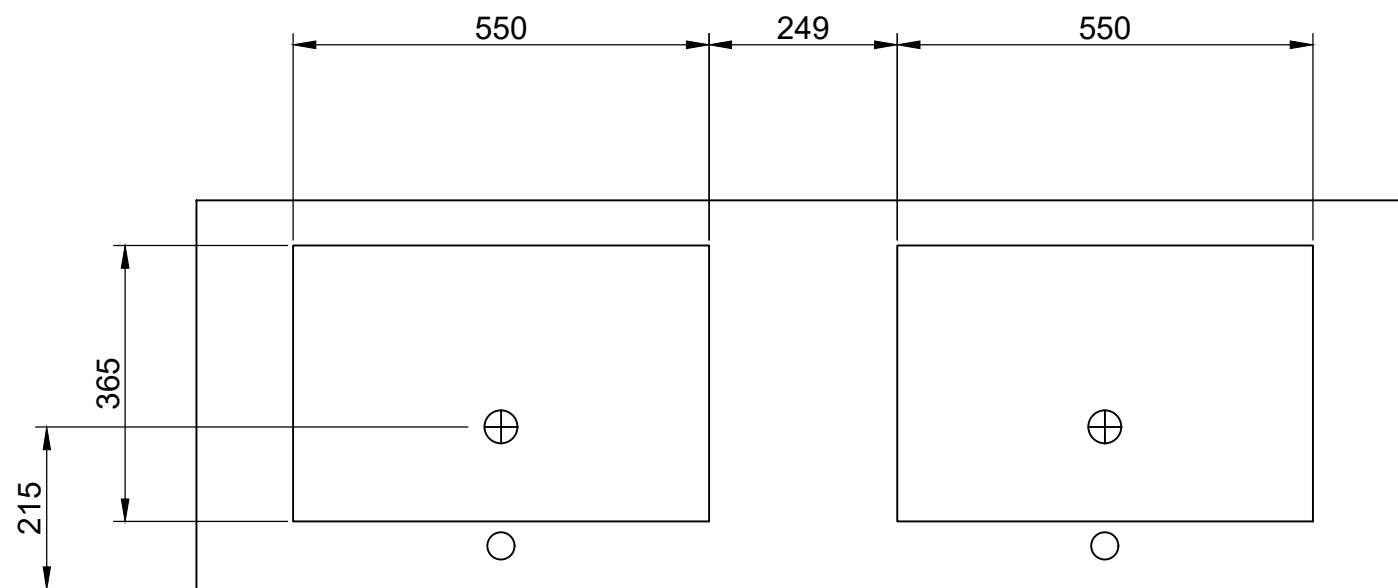

BOTTOM VIEW

UNLESS OTHERWISE SPECIFIED: DIMENSIONS ARE IN MILLIMETERS SURFACE FINISH: TOLERANCES: LINEAR: +/- 1 millimeter ANGULAR: +/- 1 degree	FINISH:	DEBUR AND BREAK SHARP EDGES	DO NOT SCALE DRAWING	REVISION
			TITLE: NOVA 160,5X51,5X9,5CM 1XØ36MM	
© all rights reserved Forzalaqua			forzalaqua	
DRAWN	NAME FKL			
APPV'D	J. Bardoel	MATERIAL:	DWG NO.	A3
MFG				
QA				
			SCALE: 1:5 / 10	SHEET 1 OF 1